

# Actuators and Controls

## LB Series Electric Actuators

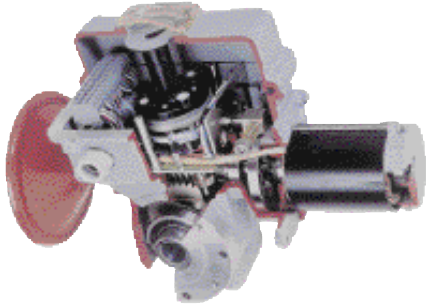

The LB-Series is available in several basic designs with a wide variety of configurations from which to select torque and speeds to meet specific application requirements. These rugged and uncomplicated actuators provide a practical and reliable method for turning any mechanism 90°. Torques range from 540 inch-pounds to 54,000 inch-pounds (6.25 to 625 kilogram-meters). Electrical models are available in 115 VAC-50/60 Hz single phase, 200 VAC-50/60 single phase; and 220/440 VAC-50/60 Hz three phase. Models are available for on/off modulating control.

Listed below are performance specifications for a limited sampling of LB-Series electric actuators. This product family is available with a such a variety of options and features that they can not be represented in this catalog. Options such as positioners, transmitters, special enclosure ratings, extra switches, or motor voltages are optionally available. Contact Conbraco's Actuator Engineering Department for the proper actuator to fit non standard or unique requirements.

LB Series Electric Actuator Performance Data							
L-B Series Model Number	Torque Output Lb-In	Rotating Speed (Sec/90 degree)		Power Requirements 30% Duty Cycle			
				115VAC 1 Ph 60Hz		460 VAC 3 Ph 60 HZ	
		Std	Opt	RATED	START	RATED	START
OA8	885	5		1.95	3.3	0.63	1.15
OA8	885	25		1.25	2	0.39	0.78
OA15	1350	15	25	1.95	3.3	0.39	0.78
AT25	2250	15		1.95	3.3	0.63	1.15
AT25	2250	25	50	1.95	3.3	0.39	0.78
AT50	4500	25		4.6	12	0.63	1.15
BT100	10600	50		4.6	12	0.63	1.15

Contact factory for part numbers of actuators with options & other voltages

### NOTES:

- Operating speed is based on an actuator operating at rated output torque. Actual operating speed will vary depending on actual output torque.
- All torque and speed ratings are based on a plus or minus 10% motor voltage variation.
- All torque ratings represent the maximum torque available during both breakaway (start) and run (dynamic) conditions.
- Each actuator is supplied, as standard, with a 30% duty cycle, F insulation, TENV design motor rated for 360 starts per hour at 104°F.
- All actuators are NEMA 4 rated as standard. Many are optionally available with additional ratings, such as, explosion proof or submersible, etc., to meet special service requirements.
- All actuators utilize a self-locking gear train design and have provision for manual override.
- All actuators have both electrical and mechanical travel stop provisions.
- **FQ Series are Spring Return Failsafe models. Contact factory for model number and price (not listed above).**

## LB Series Actuator Dimensions

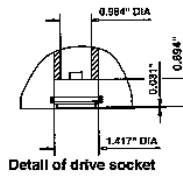
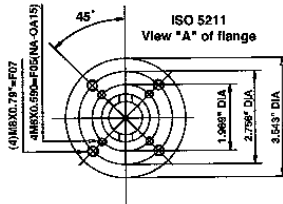
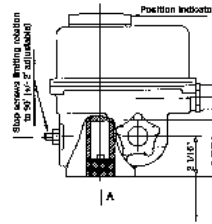
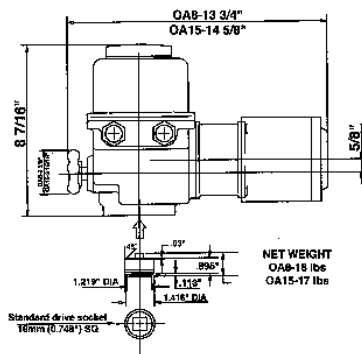

Female socket dimension = .748 square

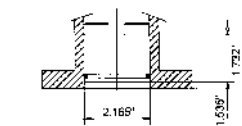
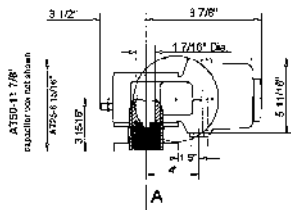
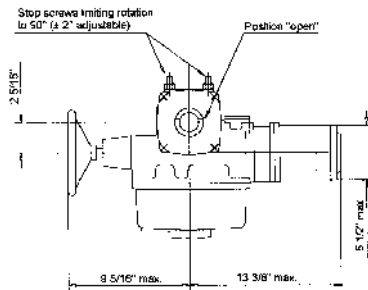
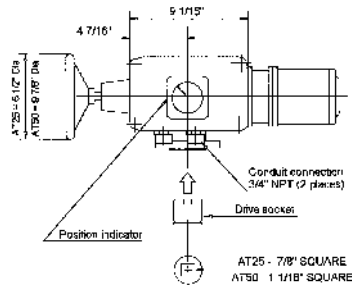
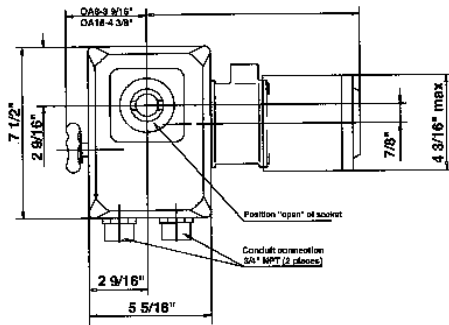

### Types OA8 and OA15

Standard specification: Weatherproof NEMA 4, with two adjustable SPDT limit switches; with built-in motor thermal cutouts, with handwheel for manual operation. Duty rating 30%.

### Types AT25 and AT50

Standard specification: Weatherproof to NEMA 4, fitted with two adjustable SPDT travel limit switches (one for each extreme position); two SPDT torque limit switches (one for each direction of rotation) and with handwheel for manual operation. Duty rating 30%. Net weight: 40 lbs.

AT25 female socket dimension = .866 square  
AT50 female socket dimension = 1.063 square

**LB Series  
Dimensions**

**Types BT100**

Standard specification: Weatherproof to NEMA 4, fitted with two adjustable SPDT travel limit switches (one for each extreme position); two SPDT torque limit switches (one for each direction of rotation) and with handwheel for manual operation. Duty rating 30%.

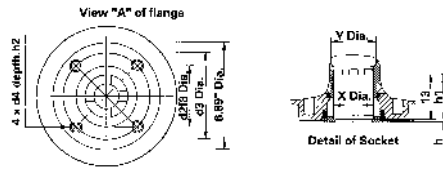
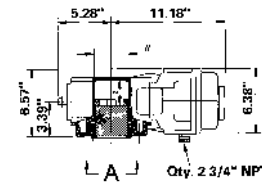
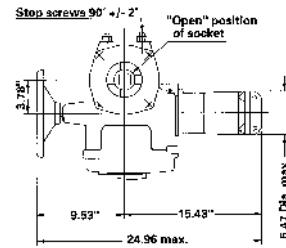
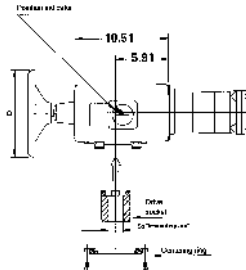

Type	D	W	X	Y	Z	I3	h1
BT100	9.84	3.35	3.23	2.36	2.52	2.99	3.01
Type	h	d3	d2I8	d4	h2	Sq.	Weight
BT100	0.16	5.51	3.94	M16	0.79	1.417	60 lbs.