



Job Name:	
Job Location:	
Engineer:	
Contractor:	
Tag:	
PO#:	
Rep:	
Wholesale Dist.:	

DESCRIPTION

The Apollo® Model DCDA4SG Double Check Detector Assembly is designed to prevent contamination of the potable water supply due to back-siphonage or backpressure from substances that are non-health hazards. The device consists of a mainline double check valve with a by-pass line. The by-pass consists of a water meter and an approved Apollo® double-check valve with Apollo® ball valves as shutoffs. The by-pass serves to measure water use of up to 3 gpm. Grooved connections on an epoxy-coated ductile iron body allow for easy connection to butterfly valves or gate valves. *Note: Model DCDA4SG replaces Model 4S-600 (also known as Model DCDA) in all sizes except 10".*

FEATURES

- Lightweight
- Short Lay Length
- Low Pressure Loss
- Modular Check Valves
- Individual Access to Check Valves
- Corrosion Resistant Epoxy-Coated Ductile Iron Body
- US Patents #5,711,341 and #6,343,618
- **Assembled and Tested in the USA**

APPROVALS

- Horizontal and Vertical Up Approvals
- ASSE 1048
- CSA B64.5
- FM Approved
- UL® Classified
- Approved by the Foundation for Cross-Connection Control and Hydraulic Research at the University of Southern California

STANDARD MATERIALS LIST

BODY (MAINLINE)	FDA Epoxy Coated Ductile Iron
BYPASS DC	Bronze (C84400/LF C89836)
COVERS (2-1/2" - 6")	FDA Epoxy Coated Steel
COVERS (8")	FDA Epoxy Coated Ductile Iron
ELBOWS	FDA Epoxy Coated Ductile Iron
CHECK VALVES (2-1/2" - 6")	Glass-Filled PPO
CHECK VALVES (8")	Bronze
SPRINGS	Stainless Steel
SEAT DISCS	Chloramine-Resistant EPDM

PERFORMANCE RATING

- Maximum Working Pressure: 175 psi
- Temperature Range: 33°F – 140°F
- Hydrostatic Test Pressure: 350 psi

***UL and FM installations must include indicating-type shutoff valves.**

PART NUMBER MATRIX

4SG [X]	60 X	X	2 X
	SIZE	METER OPTION	SHUT-OFF VALVES
4SG - STANDARD	9 - 2-1/2"	C - FT ³ /MIN	1 - LESS SHUT-OFF VALVES (SEE NOTES)
	0 - 3"	E - GPM	2 - NRS FLANGED X NRS FLANGED
	A - 4"	G - NO METER	3 - OS&Y FLANGED X OS&Y FLANGED
	C - 6"		4 - OS&Y FLANGE X MONITORED (MON.) BUTTERFLY VALVE GROOVE
	E - 8"		6 - OS&Y FLANGE X POST INDICATOR FLANGE (NOT IN 2-1/2" SIZE)
			7 - OS&Y FLANGE X OS&Y GROOVE
			8 - OS&Y GROOVE X OS&Y GROOVE
			9 - MON. BUTTERFLY VALVE GROOVE X MON. BUTTERFLY VALVE GROOVE

DIMENSIONS

SIZE	2 1/2"	3"	4"	6"	8"
A (Butterfly Valves)*	29	29-1/2	29-3/4	32	43
A (Gate Valves)*	32	33	34-1/2	39	50-1/4
B (Grooved End Body)	17	17	16-1/2	18	27
C (Butterfly Valves)	8	8-1/2	9-1/4	10-1/4	12
C (OS&Y Open)	16-3/8	18-7/8	22-3/4	30-1/8	37-3/4
D (Butterfly Valves)	4-1/2	4-1/2	4-1/2	4-1/2	6-1/2
D (Gate Valves)	3-1/2	3-3/4	4-1/2	5-1/2	6-3/4
E	9	9	9	9	10-3/4
H (Post Indicator Valve)	Not Avail.	12-3/8	14-3/4	19	22-1/2
Test Cocks (NPT)	1/2	1/2	1/2	3/4	3/4
WEIGHTS	LB.	LB.	LB.	LB.	LB.
Net Wt. (Less Valves)	65	65	65	72	395
Net Wt. (w/ Butterfly Valves)	92	95	109	140	526
Net Wt. (w/ OS&Y Valves)	161	186	220	321	872

Nominal dimensions are shown. Allowances must be made for manufacturers' tolerances.
Internal body connections are grooved on 2 1/2" - 8" sizes.

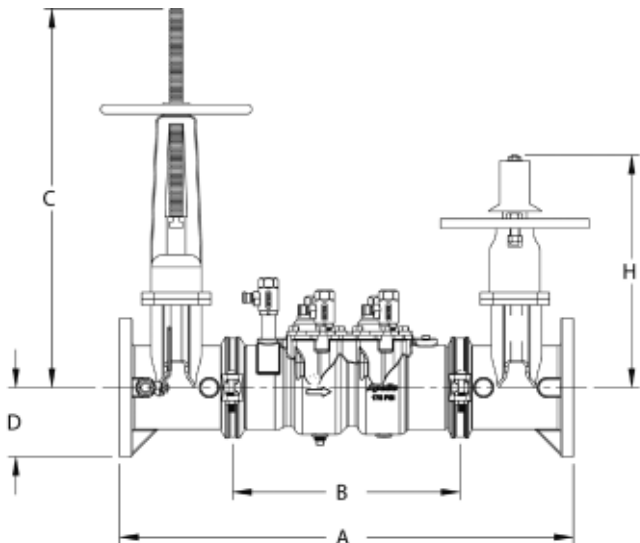
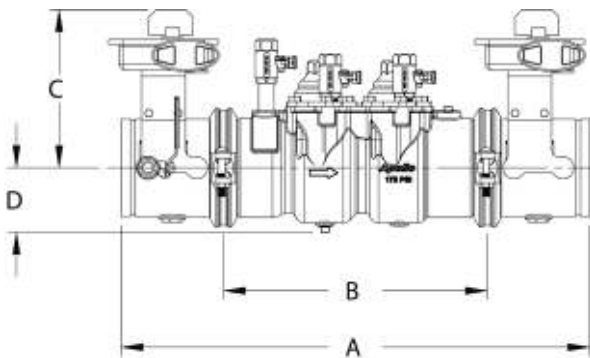
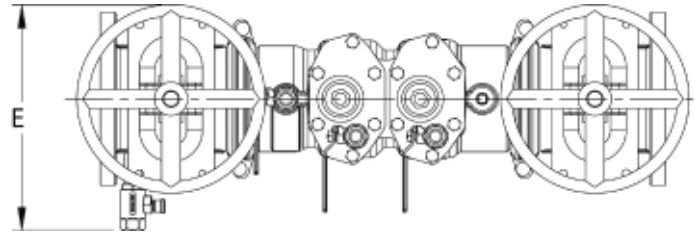
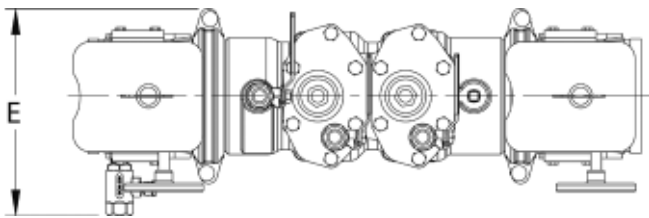

FLOW CURVES

2 1/2"

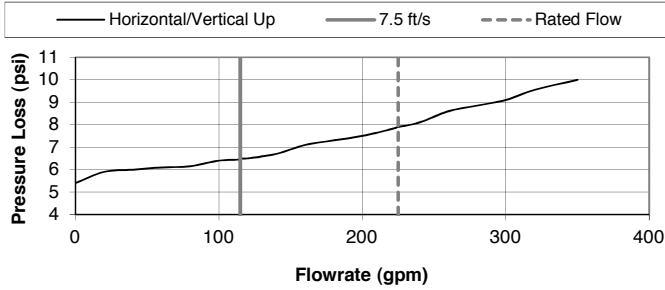

3"

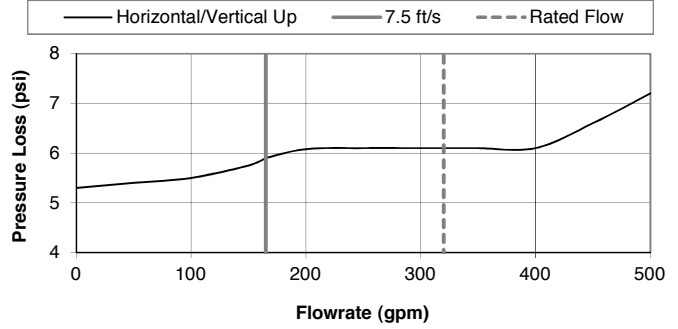

4"

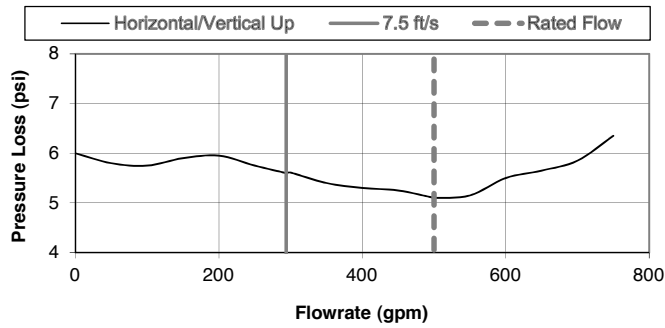

6"

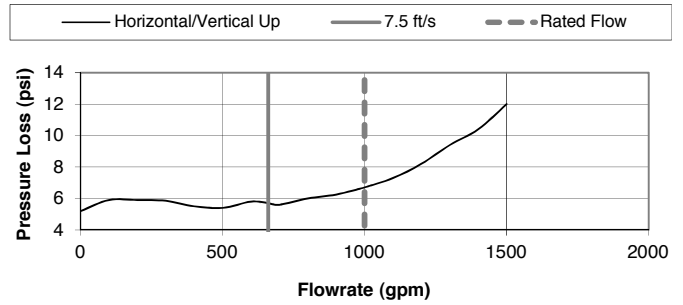

8"

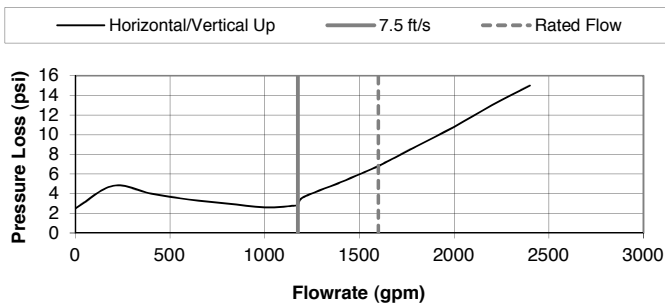

Flow curves directly reflect data collected by USC's Foundation for Cross-Connection Control and Hydraulic Research Approval curve documents.

Flow curves shown were recorded with butterfly shut-off valves.*

All data points are based on USC increasing flow data, from zero GPM to rated flow (opening curve).

Refer to Apollo Model DC4S (Formerly 4S-600 Series) for 10" valve information.

* Flow curves with gate valves are slightly lower. Contact factory for more information.