



Job Name:	
Job Location:	
Engineer:	
Contractor:	
Tag:	
PO#:	
Rep:	
Wholesale Dist.:	

DESCRIPTION

The Apollo DCLF 4SG / 4SG / 4S Series Double Check Valve is designed to prevent contamination of the potable water supply due to back-siphonage or backpressure from substances that are non-health hazards. The modular check valves have replaceable seats and reversible EPDM seat discs. Grooved connections on an epoxy-coated ductile iron body allow for easy connection to butterfly valves or gate valves (2-1/2" - 8"), flanged (10" only).

FEATURES

- Lightweight
- Short Lay Length
- Low Pressure Loss
- Modular Check Valves
- Individual Access to Check Valves
- Corrosion Resistant Epoxy-Coated Ductile Iron Body
- US Patents #5,711,341 and #6,343,618
- **Assembled and Tested in the USA**

APPROVALS

- Horizontal and Vertical Up Approvals
- ASSE 1015
- CSA B64.5
- AWWA C-510
- FM Approved
- UL® Classified
- C-UL® Classified
- Approved by the Foundation for Cross-Connection Control and Hydraulic Research at the University of Southern California
- Approved by the City of New York
- NSF/ANSI 372 Lead Free (4SGLF 2-1/2" - 6" Only)

STANDARD MATERIALS LIST

BODY	Epoxy-coated (FDA) Ductile Iron
COVERS	Epoxy-coated (FDA) Steel
CHECK VALVES	Glass-Filled Noryl® (2-1/2"-6") Bronze (8" & 10")
SPRINGS	Stainless Steel
SEAT DISCS	Chloramine-Resistant EPDM

PERFORMANCE RATING

- Maximum Working Pressure: 175 psi
- Temperature Range: 33°F - 140°F
- Hydrostatic Test Pressure: 350 psi

***UL and FM installations must include indicating-type shutoff valves.**

PART NUMBER MATRIX

4S XXX	1 X	X	XX	X
	Y-STRAINER	SIZE	SHUT-OFF VALVES (INLET X OUTLET)	OPTIONS
4SG LF - LEAD FREE (2-1/2"-6" ONLY)	0 - NONE (STANDARD) 1 - WITH Y-STRAINER	9 - 2-1/2" 0 - 3"	01 - LESS SHUT-OFF VALVES (GROOVED-END BODY) 02 - NRS FLANGE X NRS FLANGE	D - DOMESTIC ASSEMBLY
4SG - 8" ONLY	(FLANGED ONLY, SHIPPED LOOSE)	A - 4"	03 - OS&Y FLANGE X OS&Y FLANGE	
4S - 10" ONLY		C - 6" E - 8" G - 10"*	04 - OS&Y FLANGE X MONITORED BUTTERFLY VALVE GROOVE 06 - OS&Y FLANGE X FLANGE POST INDICATOR 07 - OS&Y FLANGE X OS&Y GROOVE 08 - OS&Y GROOVE X OS&Y GROOVE 09 - MON. BUTTERFLY VALVE GROOVE X MON. BUTTERFLY VALVE GROOVE 10 - OS&Y FLANGE X GROOVE POST INDICATOR	

*10" body is flanged internal connections only (Model 4S)

DIMENSIONS

MODEL NO. PART NO. SIZE	DC4SG212 4SG-109 2 1/2"	DC4SG212 4SG-109 65 MM	DC4SG3 4SG-100 3"	DC4SG3 4SG-100 80 MM	DC4SG4 4SG-10A 4"	DC4SG4 4SG-10A 100 MM	DC4SG6 4SG-10C 6"	DC4SG6 4SG-10C 150 MM	DC4SG8 4SG-10E 8"	DC4SG8 4SG-10E 200 MM	DC4S10 4S-10G 10"	DC4S10 4S-10G 250 MM
A (Butterfly Valves)*	29	737	29-1/2	749	29-3/4	756	32-1/2	815	43	1092	N/A	N/A
A (Gate Valves)*	32	813	33	838	34-1/2	876	39	991	50-1/4	1276	55-3/4	1416
B (Grooved End Body)	17	432	17	432	16-1/2	419	18	457	27	686	29-1/2	750
C (Butterfly Valves)	8	200	8-1/2	216	9-1/4	235	10-1/4	260	12	300	N/A	N/A
C (OS&Y Open)	18.8	478	20.3	515	22.1	562	29.4	747	36.8	934	45.8	1147
D (Butterfly Valves)	4-1/2	114	4-1/2	114	4-1/2	114	4-1/2	114	6-1/2	165	N/A	N/A
D (Gate Valves)	3-1/2	89	3-3/4	95	4-1/2	114	5-1/2	140	6-3/4	171	8.0	203
E (Butterfly Valves)	9	229	9	229	9-1/2	241	12	300	15	381	N/A	N/A
E (Gate Valves)	11.5	292	12	305	12.5	318	14.6	366	17.6	447	21	533
H (Post Indicator Valve)	14.75	375	14.80	376	14.80	376	18.75	476	23.42	595	26.5	673
Test Cocks (NPT)	1/2	13	1/2	13	1/2	13	3/4	20	3/4	20	3/4	20
WEIGHTS	LB.	KG.	LB.	KG.	LB.	KG.	LB.	KG.	LB.	KG.	LB.	KG.
Net Wt. (Less Shutoff Valves)	53	24	53	24	53	24	60	27	375	170	470	N/A
Ship Wt. (Less Shutoff Valves)	83	38	83	38	83	38	120	55	475	216	570	N/A
Net Wt. (w/ Butterfly Valves)	80	36	83	38	97	44	128	58	506	230	N/A	N/A
Ship Wt. (w/ Butterfly Valves)	164	75	168	76	185	84	216	98	654	297	N/A	N/A
Net Wt. (w/ Post Indicator Valves)	67	30	124	56	148	67	208	95	692	315	997	453
Ship Wt. (w/ Post Indicator Valves)	151	69	209	95	236	107	296	135	840	382	1167	530
Net Wt. (w/ OS&Y Valves)	125	57	140	64	179	81	303	138	767	349	1092	496
Ship Wt. (w/ OS&Y Valves)	209	95	225	102	264	120	391	178	915	416	1282	583

Nominal dimensions are shown. Allowances must be made for manufacturers' tolerances ($\pm 1/8"$ (3 mm) per joint)

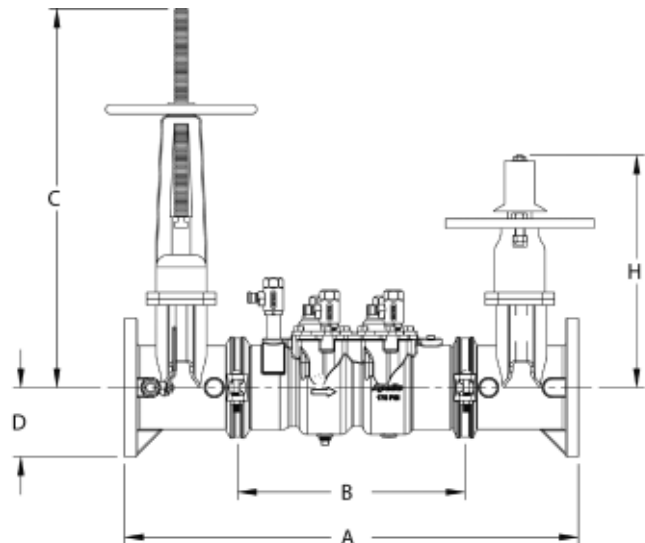
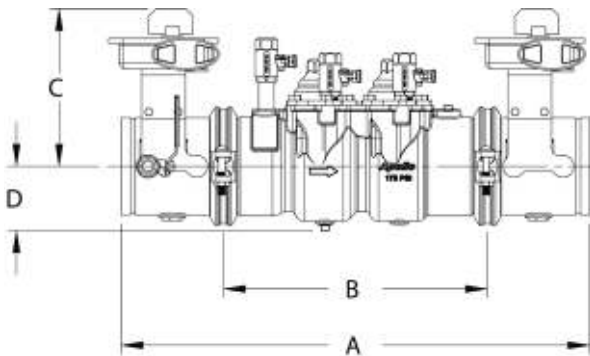
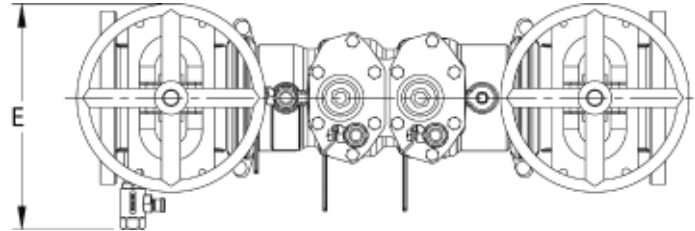
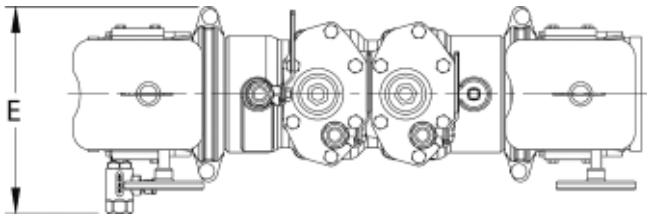

FLOW CURVES

2 1/2"

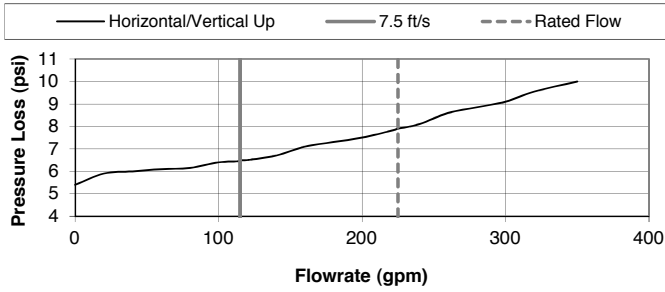

3"

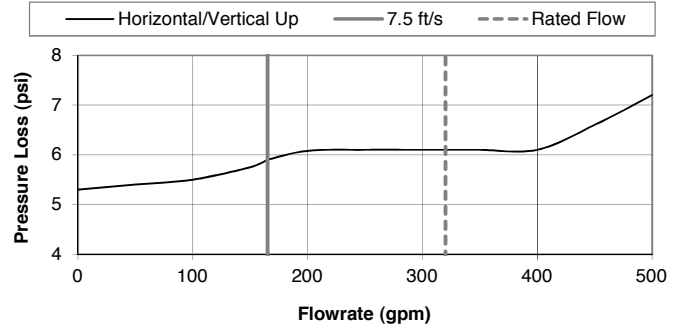

4"

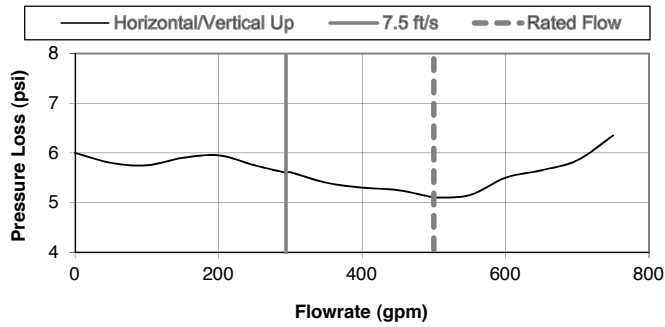

6"

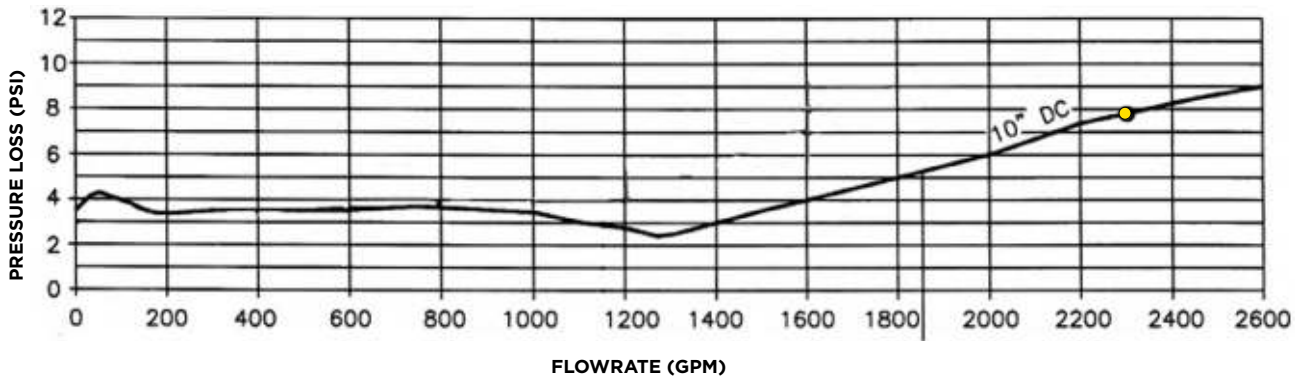
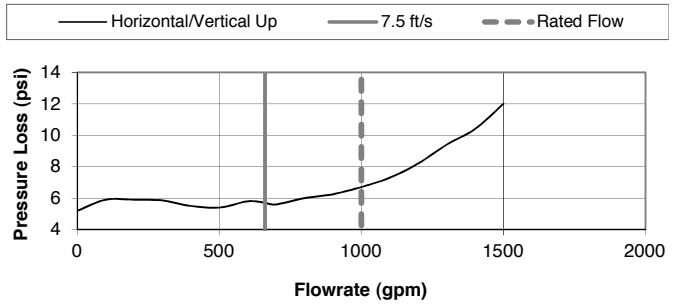

Flow curves directly reflect data collected by USC's Foundation for Cross-Connection Control and Hydraulic Research Approval curve documents.
 Flow curves shown were recorded with butterfly shut-off valves.*
 All data points are based on USC increasing flow data, from zero GPM to rated flow (opening curve).
 * Flow curves with gate valves are slightly lower. Contact factory for more information.